

## 37127 37128 N100 Flat Port 32/37

Instruction Manual

### FOREWORD

Thank you for your purchase of a NAUTICAM product.

At NAUTICAM, we pride ourselves in the ability to recognize the requirements of professional as well as amateur underwater photographers and fulfill them through the innovative designs of our products. We strive to achieve a high level of user-friendliness by allowing stress-free installation and easy operation of all important functions of the camera.

Please read this manual carefully before using the product, this will maximize its performance as well as its lifetime.

### WARRANTY

All NAUTICAM Products are warranted against any material and manufacturing defects for two years from the date of purchase for consumer use. This warranty only applies to products purchased from authorized NAUTICAM dealers and does not extend beyond the original retail purchaser.

To return your product for service, please contact your regional authorized service center(s). Please note that this warranty only applies when the product is purchased in the territory where the service center is located.

NAUTICAM does not hold responsibility for damage, of any nature, to any equipment used with and/or placed within our products.

NAUTICAM accepts no liability for any loss of captured images or the inability to capture images even if it is due to the malfunctioning of our products.

Unauthorized modifications and/or repairs of our products will automatically invalidate the warranty.

### IDENTIFICATION OF PARTS

Cold shoe

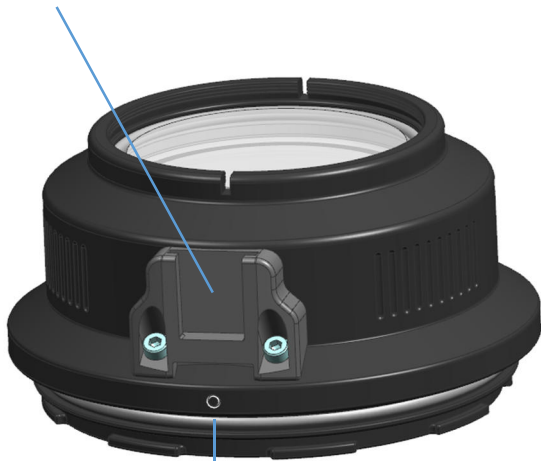

Port alignment dot

### MOUNTING THE PORT

To remove housing cap:

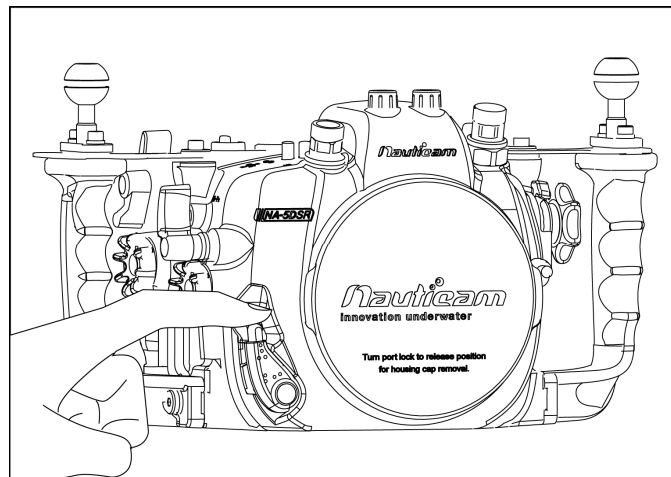

Push the safety button of the port locking lever downwards.

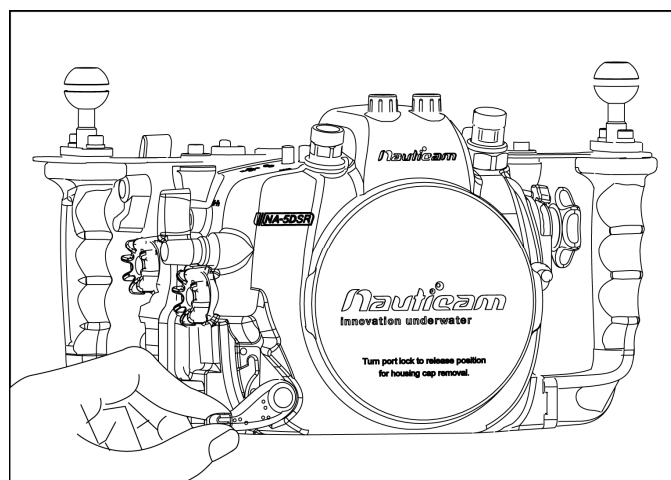

Turn the port locking lever to the release position as shown.

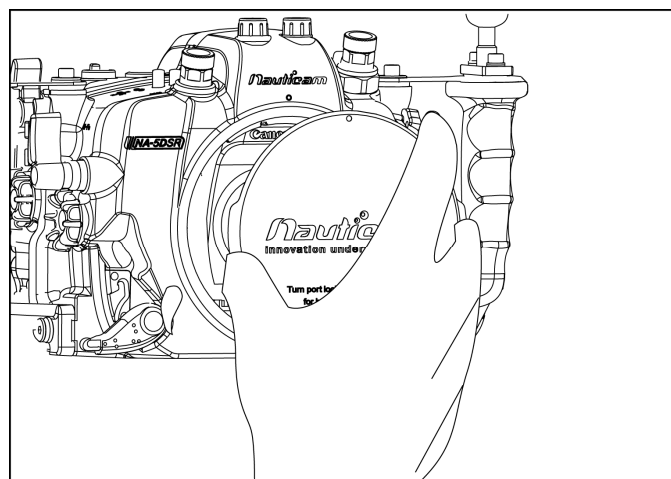

Lift the housing cap.

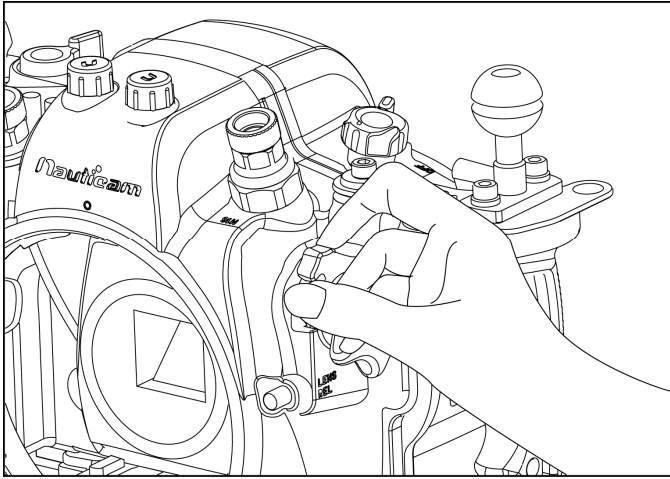

Pull the Zoom/ focus gear disengagement lever before mounting lens (with gears installed) to the camera. Engage the gears by pulling up the lever to the original position. Confirm that the zoom/focus knob operates correctly.

**To mount port:**

Remove the O-ring from the port, inspect for any damage and lightly coat it with the provided lubricant before placing it back into its groove.

Verify that the port opening of the housing is clean and free from foreign material.

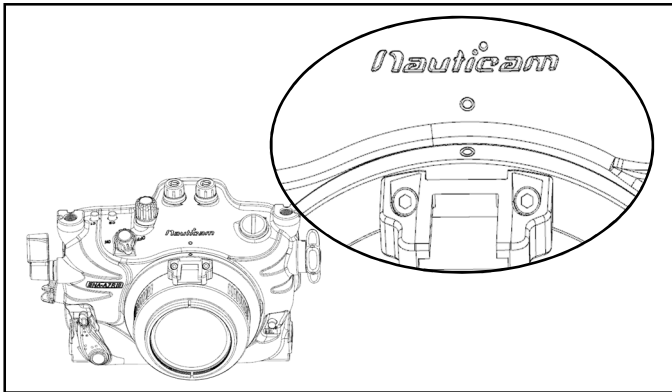

Align the mounting indices of the port and the housing; these appear as white circles on both the port and the housing.

Gently push the port into the opening of the housing, until it cannot go in any further.

Lock the port into place by turning the port locking lever to the inward position. To ensure that the port is securely mounted, confirm that the green line on the safety button of the port locking lever is visible.

To remove the port from the housing, simply turn the port locking lever to the outward position and gently pull it out.

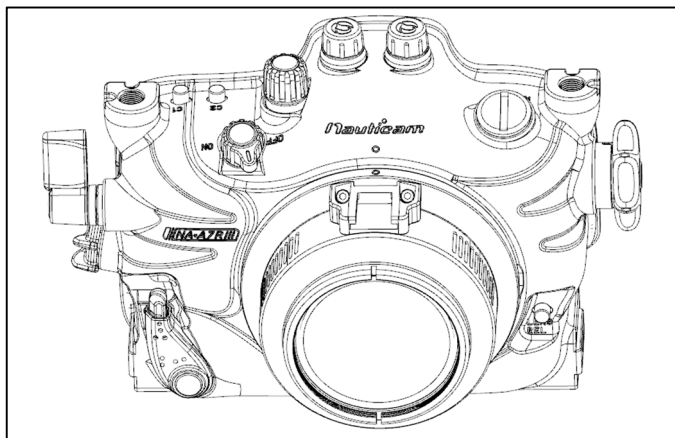

**SPECIFICATIONS**

<b>37127</b> N100 FLAT PORT 32	
Dimensions(mm):	DIA112.0x53.8
Port opening	N100
<b>37128</b> N100 FLAT PORT 37	
Dimensions(mm):	DIA112.0x58.3
Port opening	N100

Remark: Nauticam supports only e-manuals. Please download corresponding product manuals on [Nauticam.com](http://Nauticam.com) website, or contact us for e-manuals.